



# FLEXIT L14 R

## L20 R

## L30 R

## L40 R

## L60 R

### **E** Operating Instructions Air Handling Unit - Rotor



**As there are various automatic control options, the instructions do not contain a description of the automatic control. See separate automatic control documentation.**

## Contents

<b>1</b>	<b>Safety</b>	<b>3</b>
<b>1.1</b>	<b>Symbols Used</b>	<b>3</b>
<b>2</b>	<b>Transporting the Unit Inside</b>	<b>4</b>
<b>2.1</b>	<b>Lifting-/Elevation Points</b>	<b>4</b>
<b>2.2</b>	<b>Weight</b>	<b>4</b>
<b>2.3</b>	<b>Disassembly/Assembly L60 R</b>	<b>5</b>
<b>2.4</b>	<b>Sizes/Physical Dimensions L14 RE/RW</b>	<b>6</b>
<b>2.5</b>	<b>Sizes/Physical Dimensions L20 RE/RW</b>	<b>7</b>
<b>2.6</b>	<b>Sizes/Physical Dimensions L30 RE/RW</b>	<b>8</b>
<b>2.7</b>	<b>Sizes/Physical Dimensions L40 RE/RW</b>	<b>9</b>
<b>2.8</b>	<b>Sizes/Physical Dimensions L60 RE/RW</b>	<b>10</b>
<b>3</b>	<b>Installation</b>	<b>11</b>
<b>3.1</b>	<b>Inspection/Maintenance</b>	<b>11</b>
<b>3.2</b>	<b>Space Required</b>	<b>11</b>
<b>3.3</b>	<b>Stop Damper in Air Intake/Exhaust (Accessory)</b>	<b>11</b>
<b>3.4</b>	<b>Technical Room Requirements</b>	<b>11</b>
<b>3.5</b>	<b>Recommended Sound Absorption and Sound Transfer</b>	<b>11</b>
<b>4</b>	<b>Electrical Works</b>	<b>12</b>
<b>4.1</b>	<b>Main Supply (Mains Cable)</b>	<b>12</b>
<b>4.2</b>	<b>Connection of External Components</b>	<b>12</b>
<b>4.3</b>	<b>Earth-leakage Circuit-breaker</b>	<b>12</b>
<b>4.4</b>	<b>Installation</b>	<b>12</b>
<b>5</b>	<b>Plumbing Works</b>	<b>13</b>
<b>5.1</b>	<b>Technical Data for Water Batteries</b>	<b>13</b>
<b>5.2</b>	<b>Possible Valve Types</b>	<b>13</b>
<b>5.4</b>	<b>Possible Valve Motor</b>	<b>13</b>
<b>5.5</b>	<b>Connections</b>	<b>13</b>
<b>6</b>	<b>General Drawings and System Drawings</b>	<b>14</b>
<b>7</b>	<b>Adjustment, Capacity and Sound Data</b>	<b>15</b>
<b>7.1</b>	<b>Cleaning</b>	<b>16</b>
<b>7.2</b>	<b>Pressure Balance</b>	<b>16</b>
<b>7.3</b>	<b>Capacity Diagram, Sound Data, Specifications - Flexit L14 R W/E</b>	<b>17</b>
<b>7.4</b>	<b>Capacity Diagram, Sound Data, Specifications - Flexit L20 R W/E</b>	<b>18</b>
<b>7.5</b>	<b>Capacity Diagram, Sound Data, Specifications - Flexit L30 R W/E</b>	<b>19</b>
<b>7.6</b>	<b>Capacity Diagram, Sound Data, Specifications - Flexit L40 R W/E</b>	<b>20</b>
<b>7.7</b>	<b>Capacity Diagram, Sound Data, Specifications - Flexit L60 R W/E</b>	<b>21</b>
<b>8</b>	<b>Maintenance</b>	<b>22</b>
<b>8.1</b>	<b>Troubleshooting</b>	<b>22</b>
<b>9</b>	<b>Technical Specifications</b>	<b>23</b>
<b>9.1</b>	<b>Technical Specifications - L14 R</b>	<b>23</b>
<b>9.2</b>	<b>Technical Specifications - L20 R</b>	<b>23</b>
<b>9.2</b>	<b>Technical Specifications - L30 R</b>	<b>24</b>
<b>9.3</b>	<b>Technical Specifications - L40 R</b>	<b>24</b>
<b>9.4</b>	<b>Technical Specifications - L60 R</b>	<b>25</b>
<b>10</b>	<b>Commissioning</b>	<b>25</b>
<b>11</b>	<b>EU Declaration of Conformity</b>	<b>26</b>
<b>12</b>	<b>Product/Environmental Declaration</b>	<b>27</b>

*Our products are subject to continuous development and we therefore reserve the right to make changes.  
We also disclaim liability for any printing errors that may occur.*

# 1 Safety

## CAUTION



**Check that the unit is dead before opening it for service or maintenance.**

- Only personnel with the relevant technical skills may perform maintenance work.
- The switch for all-pole breaking must be off when the inspection doors are opened and all rotating parts must have stopped.
- Use the unit's service switch to stop the unit. Units with electric heating batteries must run for 3 minutes before stopping so that the battery is cooled down.
- Check that the doors are properly closed after service has been performed.
- If open bosses or short duct(s) are used, the fans must be protected with protective grids.

### 1.1 Symbols Used

This product has a number of symbols that are used to label the product itself and in the installation and user documentation. Here is an explanation of some of the commonest symbols.



**Supply air**

SUPPLY AIR



**Extract air**

EXTRACT AIR



DANGER! ELECTRICITY

DANGER! DO NOT TOUCH

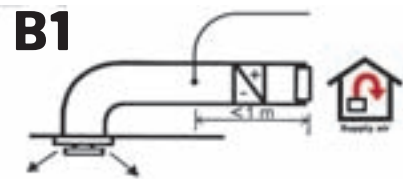

**B1**  
SUPPLY AIR TEMPERATURE SENSOR



**Exhaust air**

EXHAUST AIR



**Outdoor air**

OUTDOOR AIR

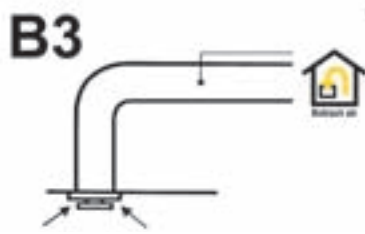

**B3**  
EXTRACT AIR TEMPERATURE SENSOR

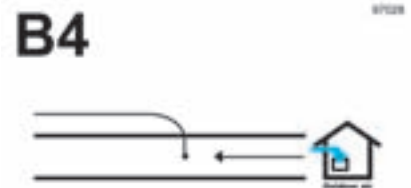

**B4**  
OUTDOOR AIR TEMPERATURE SENSOR



**CAUTION:** When a text bears this symbol, it means that personal injury or serious damage to the equipment may follow if the instructions are not followed.



**NB:** When a text bears this symbol, damage to equipment or a poor utilisation ratio may be the consequence of not following the instructions.

## 2 Transporting the Unit Inside

### 2.1 Lifting-/Elevation Points

The unit must be lifted using lifting straps (Fig. 1) or a truck/jack trolley (Fig. 2). When using lifting straps they must be placed far enough apart to avoid tipping the ventilation unit. Use shores (boards) where the straps are in contact with the unit (as shown in Fig. 1), to avoid disfiguration from the straps. Remember to use 2 jack trolleys/trucks, one from each side, to avoid the unit tipping down onto the floor and the base being damaged.

If you choose to use jack trolleys or trucks to lift the unit in the middle, use equipment that has sufficiently long forks. The forks on the jack trolley/truck should correspond at least to the width of the unit.



Fig. 1



Fig. 2

**L60 R** consists of three modules which can be separated for transportation and installation (Fig. 3):

A - Supply air module

B - Rotor module

C - Exhaust air module

See next page (chapt. 2.3) for disassembly into separate sections.

The arrows indicate the anchorage points (another set at the back).

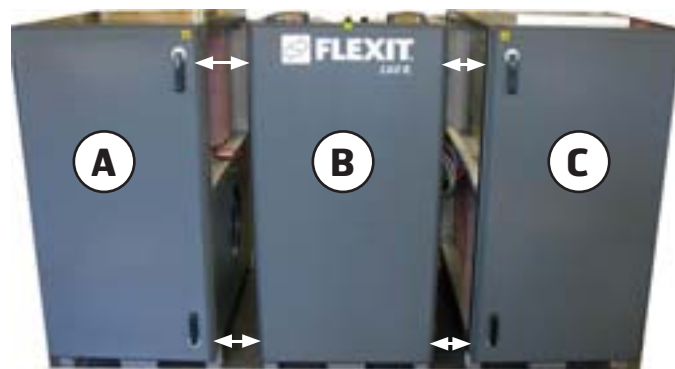

Fig. 3

### 2.2 Weight

	COMPLETE UNIT					EACH MODULE (L60 R)		
	L14 R	L20 R	L30 R	L40 R	L60 R	A	B	C
Gross unit weight	175 kg	252,5 kg	330 kg	363,5 kg	540 kg	160 kg	220 kg	160 kg
Fans	14 kg	19,5 kg	24,5 kg (2 pcs)	27 kg (2 pcs)	42 kg (2 pcs)	42 kg		42 kg
Heat recovery system	35 kg	48,5 kg	62 kg	68 kg	110 kg		110 kg	
Doors	11,5 kg (2 pcs)	19 kg (2 pcs)	9 kg (4 pcs) 12,5 kg (2 pcs)	9,5 kg (4 pcs) 12,5 kg (2 pcs)	12 kg (4 pcs) 18 kg (2 pcs)	12 kg (2 pcs)	18 kg (2 pcs)	12 kg (2 pcs)
Net weight for transport inside	103 kg	146,5 kg	158 kg	178,5 kg	262 kg	94 kg	74 kg	94 kg



**When the rotor is removed, the contacts for the rotor must be released (se kap. 2.3).**

**2.3 Disassembly/Assembly**

The 3 separate modules of the ventilation unit (A,B and C) are connected at the top and bottom, both in the front (4 screws/M8) and at the rear (4 screws/M8), with guide cones and connecting screws (fig 3 page 4).

**Notice:** When remounting, the Exhaust air (C page 4) and Rotor-module (B page 4), must be connected first. This is done because of the difficulty of reaching the 2 screws connecting the modules on the backside. Not until these 2 modules are screwed together the modules may be moved to their final location.

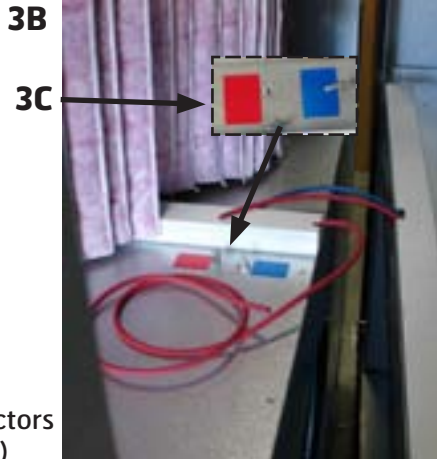
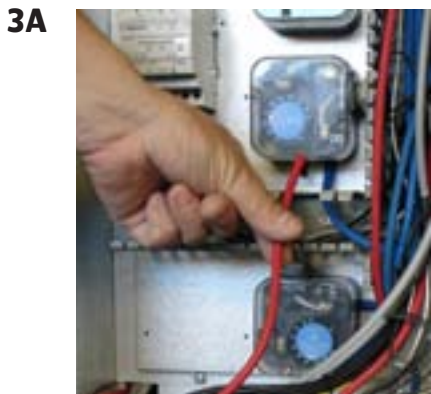

**Step 1:** When disassembling the connectors (1) and the rubber tubes (2B/3B) each unit module must first be disconnected (fig. 3 page 4). Unscrew the lid which the connectors enter and pull the connectors through the whole (2A/2B).

**Step 2:** Remove the red tube entering at P2 (pressure guard, extract air filter), and pull it out of the module (3A). Remove the rest of the tubes connected to the fans (fig. 3B). It is important that the tubes are not mixed up when reassembling! Check colour coding at the nipples (3C).

In order to access the tubes on the exhaust air side of the unit (fig. 3 page 4/module C) the extract fan must be moved.

Remove the blue tube between the fan cone and the separating wall (4A). Remove the 4 screws holding the fan rig and push the complete fan set-up backwards(4B) so that the rotor appears. Remove the tubes entering below the rotor (4C). Then remove the blue tube entering above the rotor (4D).

**Step 3:** The 3 modules for supply air, rotor and extract air kan now be separated (fig. 3 page 4). Reassemble in reverse order.

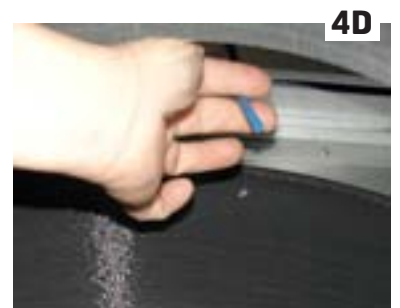

## 2.4 Sizes/Physical Dimensions L14 RE/RW

### L14 RE

As standard, the unit has 2 exhaust air nipples, one on the end and one on the top. The one on the top is covered with a cover. This cover can easily be unscrewed and moved to the exhaust air nipple on the end, if required.

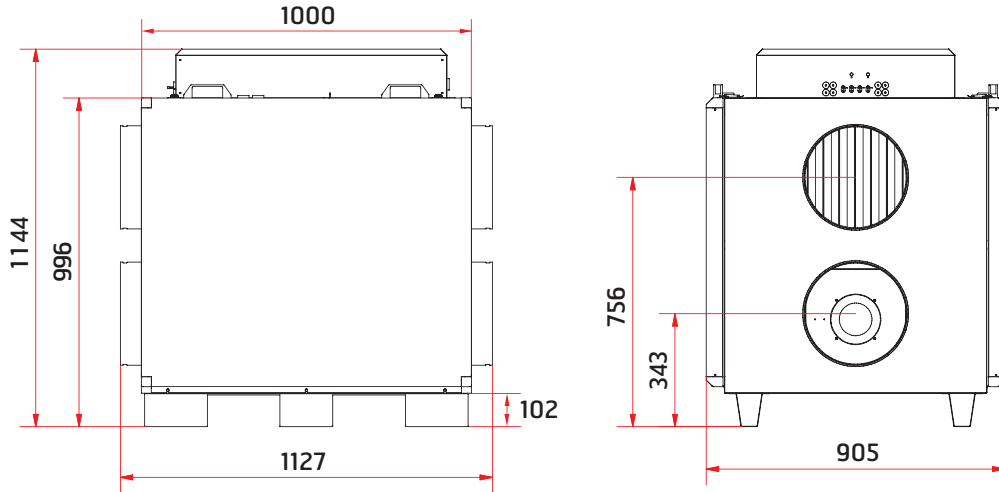

All dimensions in mm

Fig. 4

The dimensions are the same on both end sides. The drawings show a right hand model.

### L14 RW (Water battery)

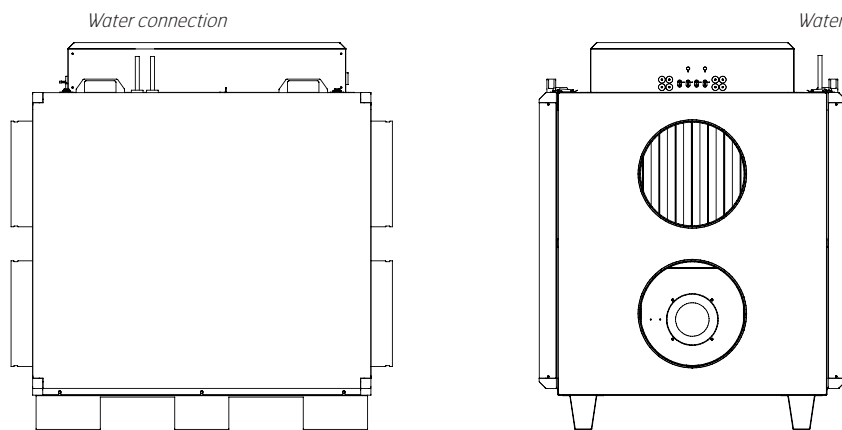

All dimensions in mm

Fig. 5

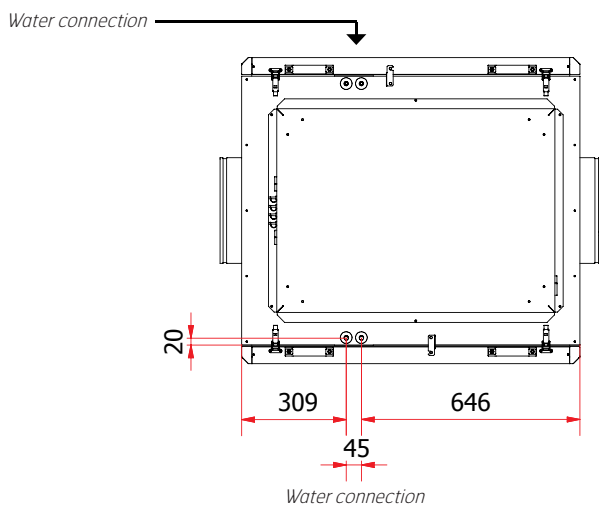

#### With a water battery:

It is important for water pipes not to block doors or prevent the removal of the heat recovery system, water coil, filters and fans. Connection for water coil must be on "service side".

**2.5 Sizes/Physical Dimensions L20 RE/RW**

**L20 RE**

As standard, the unit has 2 exhaust air nipples, one on the end and one on the top. The one on the top is covered with a cover. This cover can easily be unscrewed and moved to the exhaust air nipple on the end, if required.

*All dimensions in mm*

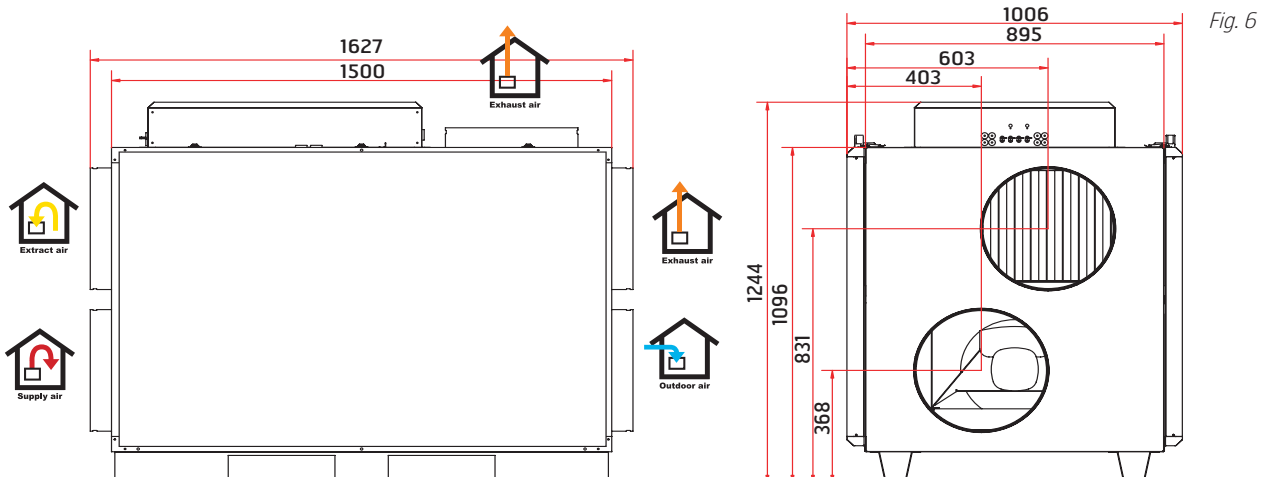

*The dimensions are the same on both end sides.*

*NB! The units have doors on each side so that they can be operated from either side.*

**L20 RW (Water battery)**

*All dimensions in mm*

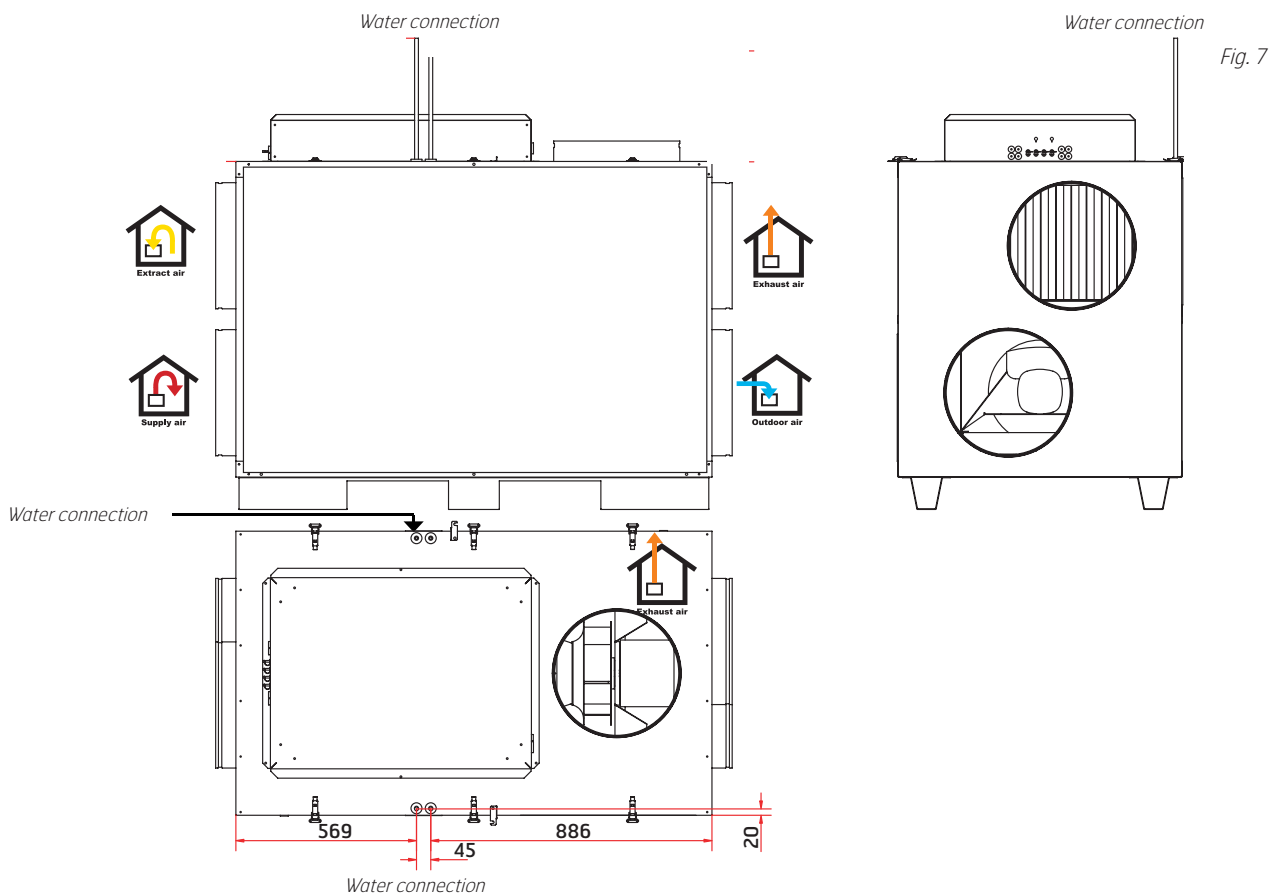

**With a water battery:**

**It is important for water pipes not to block doors or prevent the removal of the heat recovery system, water coil, filters and fans. Connection for water coil must be on "service side".**

## 2.6 Sizes/Physical Dimensions L30 RE/RW

### L30 RE

As standard, the unit has 2 exhaust air nipples, one on the end and one on the top. The one on the top is covered with a cover. This cover can easily be unscrewed and moved to the exhaust air nipple on the end, if required.

All dimensions in mm

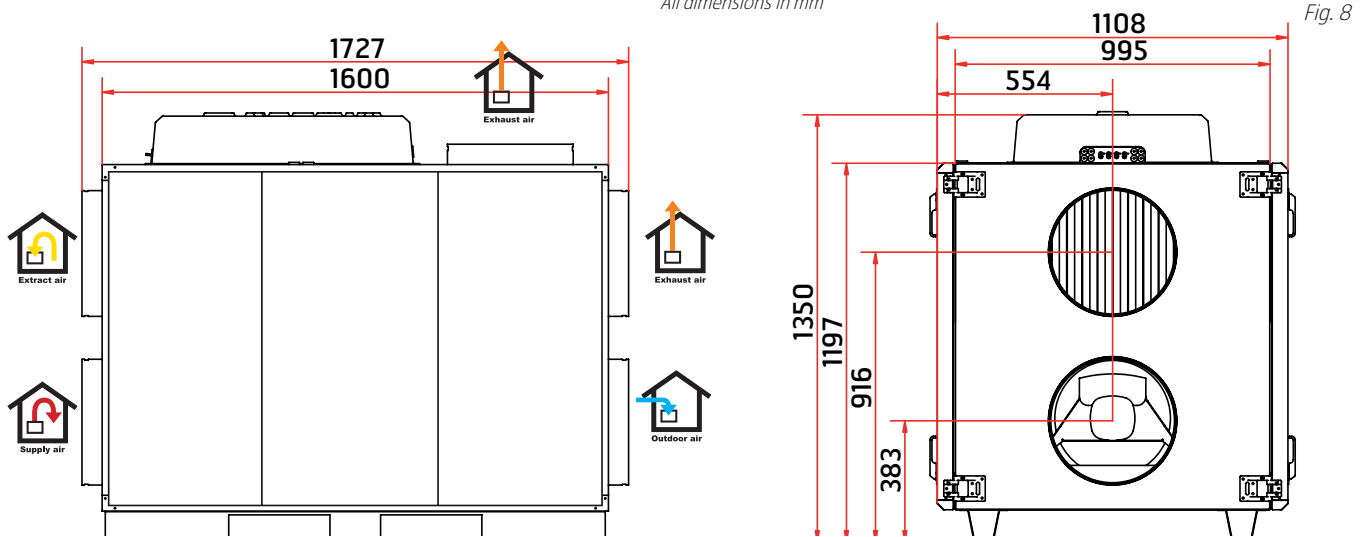

The dimensions are the same on both end sides.

NB! The units have doors on each side so that they can be operated from either side.

### L30 RW (Water battery)

All dimensions in mm

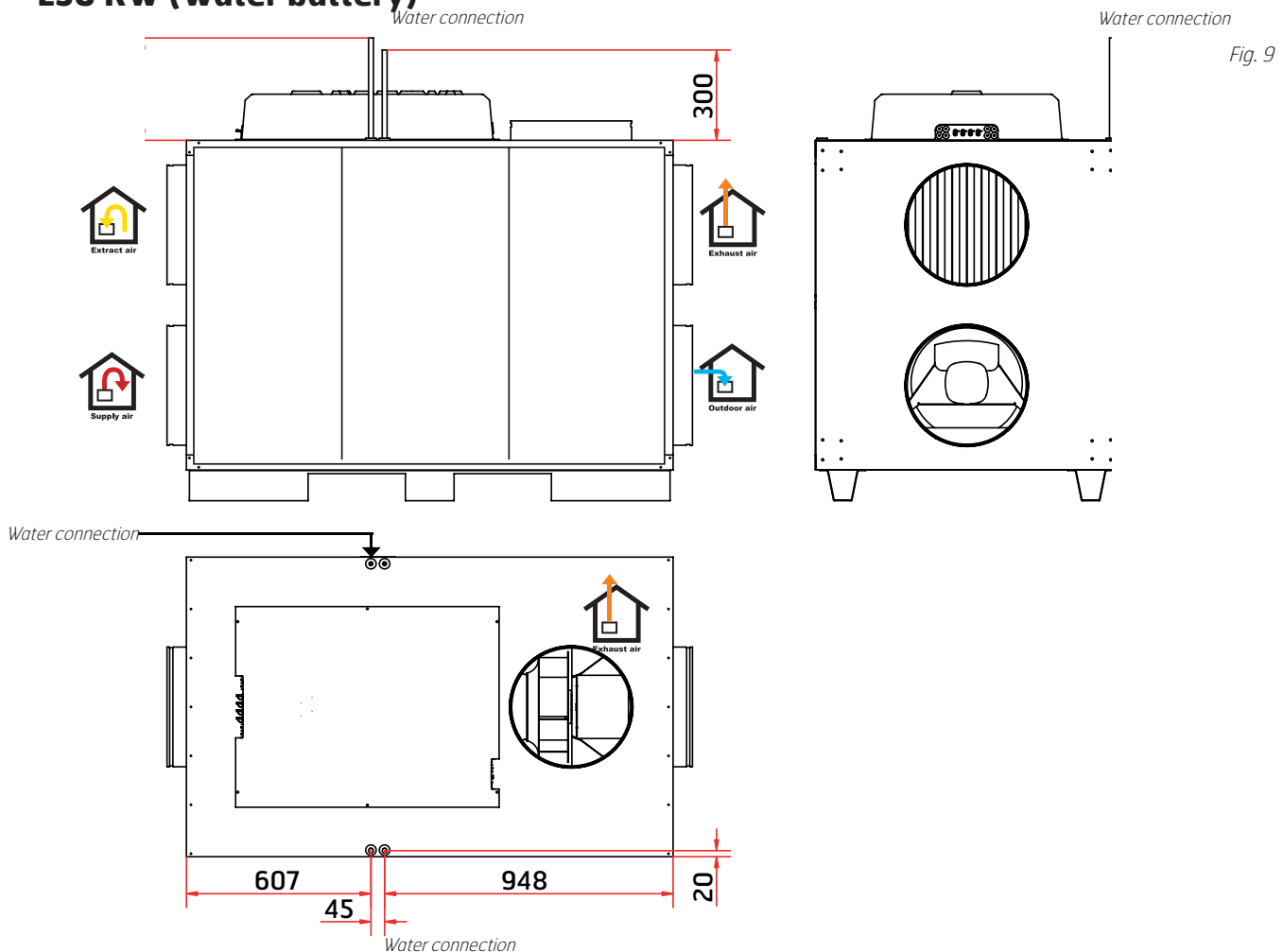

#### With a water battery:

It is important for water pipes not to block doors or prevent the removal of the heat recovery system, water coil, filters and fans. Connection for water coil must be on "service side".



**2.7 Sizes/Physical Dimensions L40 RE/RW**

**L40 RE**

As standard, the unit has 2 exhaust air nipples, one on the end and one on the top. The one on the top is covered with a cover. This cover can easily be unscrewed and moved to the exhaust air nipple on the end, if required.

All dimensions in mm

Fig. 10

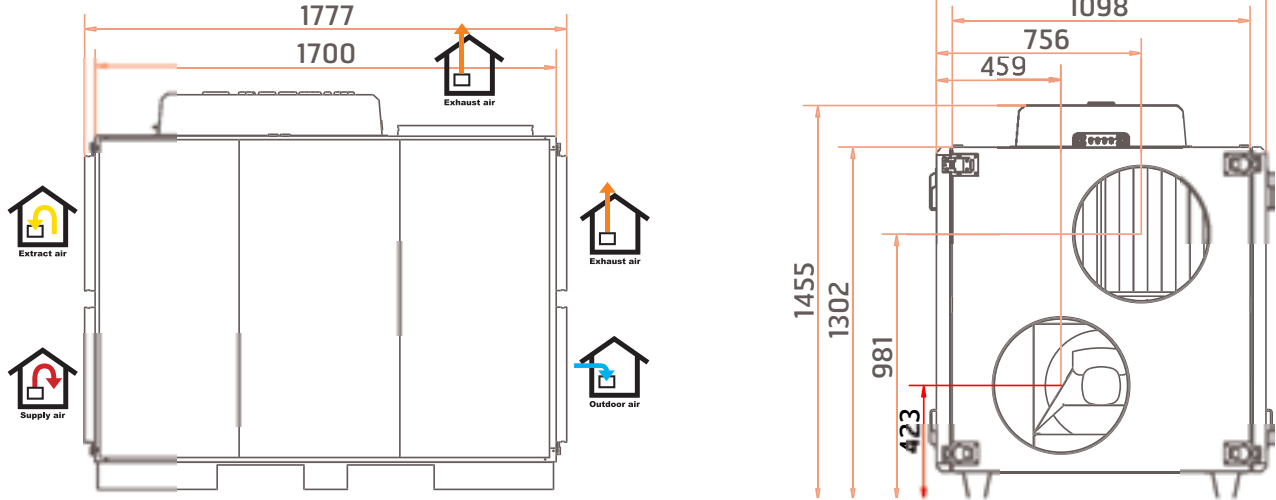

The dimensions are the same on both end sides.

NB! The units have doors on each side so that they can be operated from either side.

**L40 RW (Water battery)**

All dimensions in mm

Fig. 11

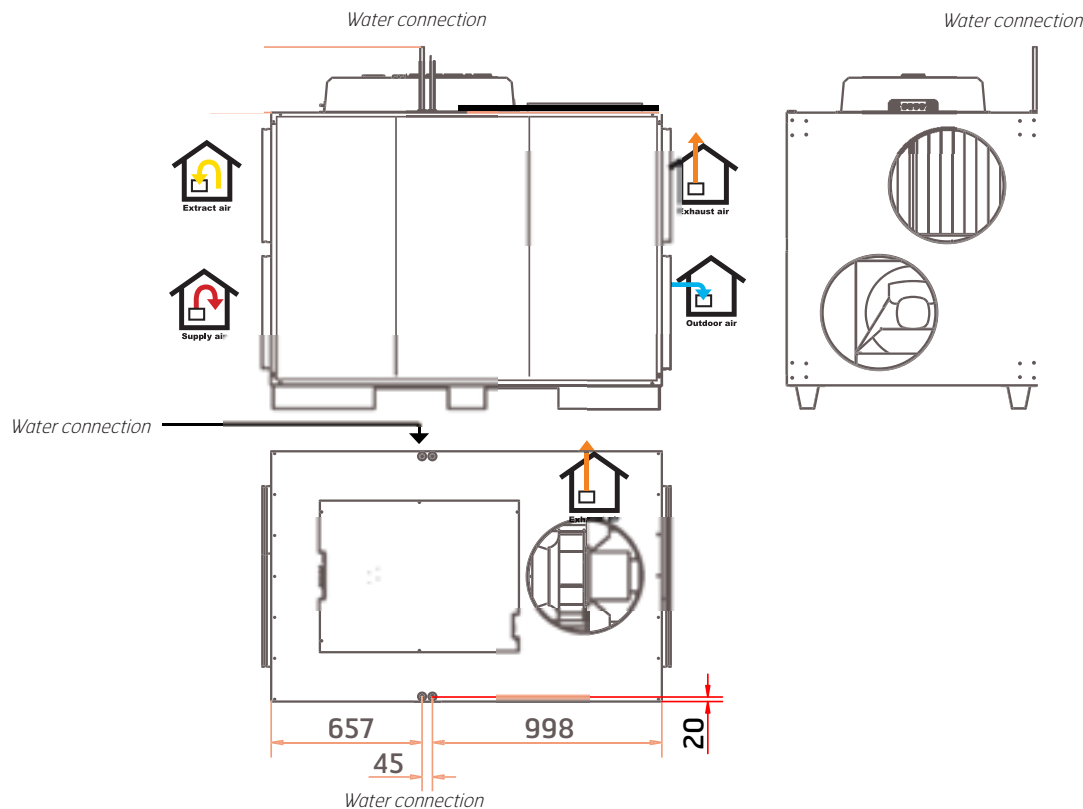

**With a water battery:**

It is important for water pipes not to block doors or prevent the removal of the heat recovery system, water coil, filters and fans. Connection for water coil must be on "service side".

## 2.8 Sizes/Physical Dimensions L60 RE/RW

### L60 RE

As standard, the unit has 2 exhaust air nipples, one on the end and one on the top. The one on the top is covered with a cover. This cover can easily be unscrewed and moved to the exhaust air nipple on the end, if required.

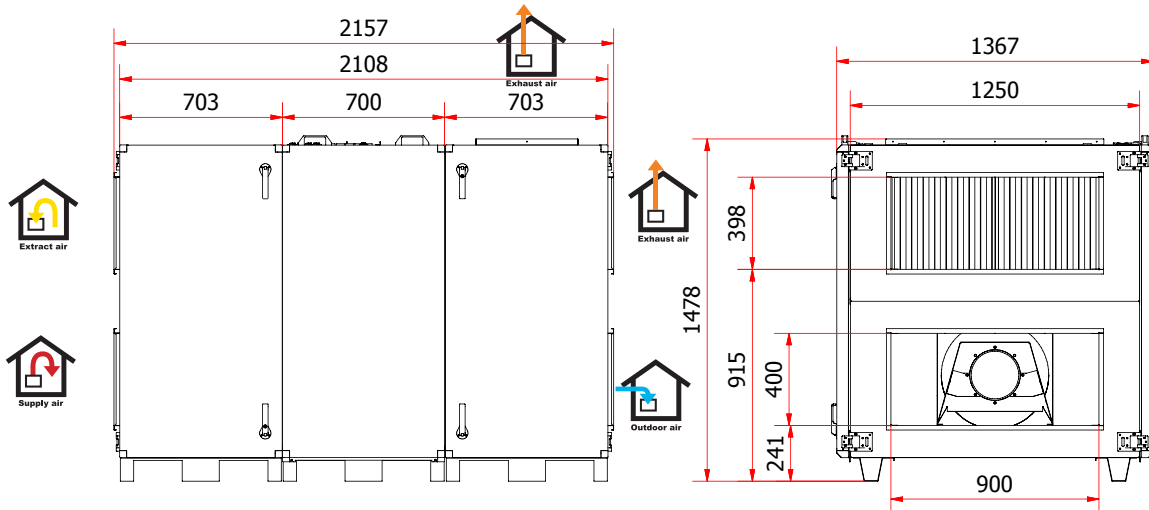

All dimensions in mm

Fig. 12

The dimensions are the same on both end sides. Drawing shows a right hand model.

### L60 RW (Water battery)

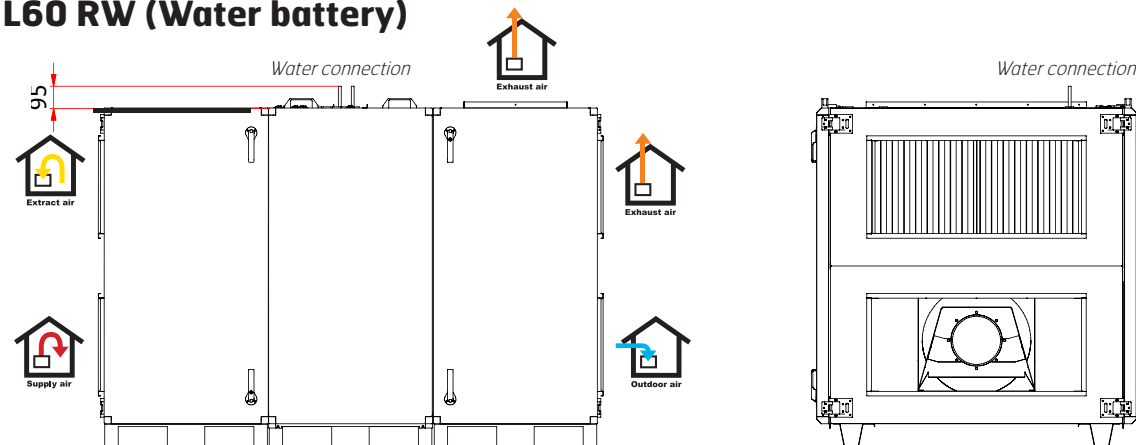

All dimensions in mm

Fig. 13

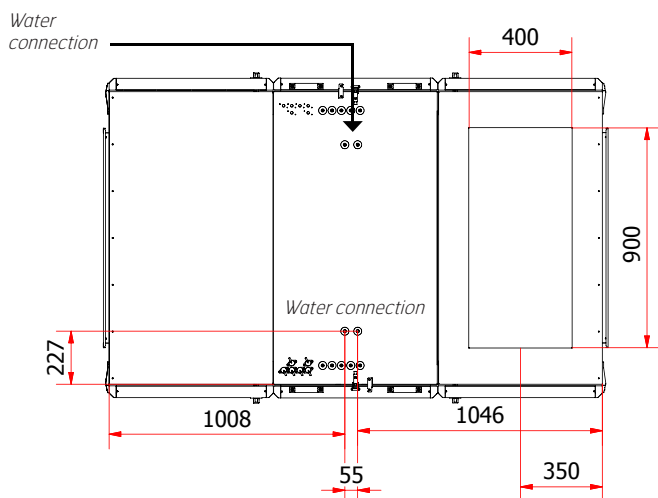

#### With a water battery:

It is important for water pipes not to block doors or prevent the removal of the heat recovery system, water coil, filters and fans. Connection for water coil must be on "service side".

### 3 Installation

**△** The unit is designed for indoor installation.

#### 3.1 Inspection/Maintenance

The unit must be installed with space for service and maintenance such as filter replacement and cleaning the fans and recovery system. It is also important for the unit to be located so that the electrical cabinet is easily accessible for electrical connection, troubleshooting and future component replacement.

#### 3.2 Space Required

Type	A	B
L14 R	100 mm	1000 mm
L20 R	1100 mm	1000 mm
L30 R	1200 mm	1000 mm
L40 R	1300 mm	1000 mm
L60 R	1500 mm	500 mm

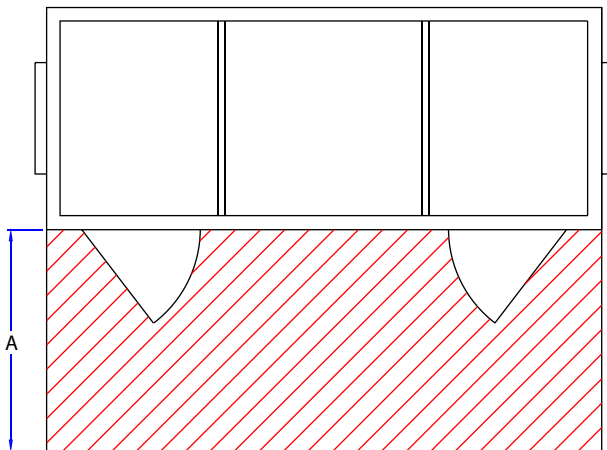

#### 3.5 Recommended Sound Absorption and Sound Transfer

The main silencers must be placed near the unit, preferably in the technical room. The unit should be placed by a wall that has no room on the other side that is sensitive to noise. The unit should not be less than 400 mm from the wall. If the unit is placed against a wall, low-frequency sound may create vibrations in the wall. Sound may also be transferred through the floor if the mass and rigidity of the floor are not sufficient. Technical rooms should be fitted with floating concrete floors to prevent sound transfer on account of vibration. When installing the unit, fabric bosses must be fitted between the unit and the duct system. It is also important for the unit not to bear the weight of the ducts. Busbars or water pipes must not prevent the unit from moving freely on the vibration dampers.

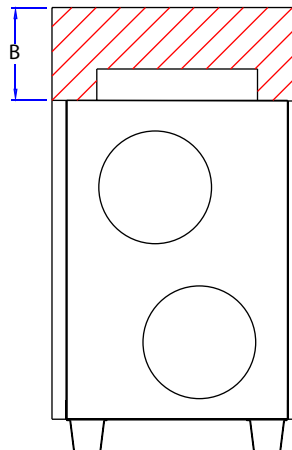

Fig. 14

See the separate dimensioned drawing for connection of the water battery (pipe location), Chap. 2.3. These are minimum requirements that only take service needs into account. National statutory requirements for electrical safety may deviate from this. Check which rules apply in your country.

#### 3.3 Stop Damper in Air Intake/Exhaust (Accessory)

Used to prevent self-ventilation when the unit is stopped. Must always be used in systems with water batteries as protection against frost.

#### 3.4 Technical Room Requirements

**△** The unit must be placed in a separate technical room. Ceiling/floor/walls/doors must be in the necessary fire class. If the unit has a water battery, the room must have a gully in case the battery freezes.

## 4 Electrical Works



All electrical works must be performed by an authorised electrician

- See the separate instructions for the automatic control and its installation
- See the separate wiring diagram in the unit for external connections
- See also Chapter 9 Technical Data for more information on electrical wiring
- A service switch must be installed for all-pole breaking of the supply voltage to the unit.  
This is not included in the supply from FLEXIT
- The electrical components must not be exposed to temperatures lower than  $-23^{\circ}\text{C}$  or higher than  $+55^{\circ}\text{C}$

### 4.1 Main Supply (Mains Cable)

L20 R, L30 R and L40 R requires just 1 mains cable. See the separate table in Chapter 9 Technical Data for the exact dimensions.

### 4.2 Connection of External Components

See the separate wiring diagram enclosed with each unit. All electrical connections must be installed by qualified electricians.

### 4.3 Earth-leakage Circuit-breaker

The frequency converter must be earthed to comply with the regulations concerning high leakage currents (over 3.5 mA). If a line-side earth-leakage circuit-breaker is used as protection in accordance with the installation regulations, an earth-leakage circuit-breaker type B must be installed, which functions even if there are DC components. See the symbol in Fig. 15.



Fig. 15 Earth-leakage symbol

### 4.4 Installation

Check that cable ducts are not permanently installed between the unit and the wall. This can lead to sound transfer (vibrations).



**Tighten all terminal blocks before finishing the work to avoid heat generation in the connections, which may result in fire in the worst case scenario.**

## 5 Plumbing Works



**All plumbing work must be performed by an authorised plumber.**

### 5.1 Technical Data for Water Batteries

Unit	Water battery-connection	Pipe connection
L14 R	R 1/2"	cu Ø12
L20 R	R 1/2"	cu Ø12
L30 R	R 1/2"	cu Ø12
L40 R	R 1/2"	cu Ø12
L60 R	R 1/2"	cu Ø12

For further information, please refer to the special estimation program for calculation of technical data for the water battery ([www.flexit.com](http://www.flexit.com)).

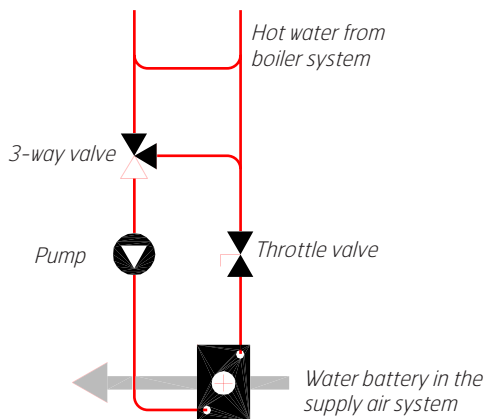

Fig. 16 Recommended connection

### 5.2 Possible Valve Types

3-way valve, type Honeywell, for capacity:  
 1.6 kvs art. no. 56232  
 2.5 kvs art. no. 57228  
 4.0 kvs art. no. 56283

2-way valve, type Honeywell, for capacity:  
 1.6 kvs art. no. 56432  
 2.5 kvs art. no. 56433  
 4.0 kvs art. no. 56434

### 5.4 Possible Valve Motor

It is necessary to use a valve motor that is controlled by 0-10 V, where 10 V=100 % open.  
 Valve motor article number: 56234.

### 5.5 Connections



**Before connecting the water battery, it is necessary to check that the inspection doors are accessible and there is space enough to change the water battery.**

Use the recommended connection (see Fig. 16) unless specified otherwise. The water supply must be at the bottom of the water battery - the return must be on the top.

Place the adjustment valve as close to the unit as possible. (Please note that many valve motors can go in both directions and this can be set on the motor. Set it so that the valve opens on an increasing 0-10 V signal.)



**The water batteries cannot be vented as this serves no purpose. If the unit's water battery is the highest point in the circuit, a venting valve must be installed after the unit.**

If you use a water battery that has not had glycol (or another antifreeze) added, the unit should be in a heated room on account of the risk of frost in the battery. Install air dampers with spring-loaded return for outdoor air. Place the unit close to a gully to avoid damage caused by any water leaks. Install pipe routes to the water battery so that there is free access to the motor and recovery system. Remember vibration damping for water pipes.

You can see the location of pipes out of the unit in the dimensioned drawings in Chap. 2.3.



**Install the water battery so that there is free access to the motor and recovery system.**  
**Pipe routes for water pipes:**  
**Remember vibration damping for water pipes.**

## 6 General Drawings and System Drawings

General Picture - Rotary Wheel-type Heat Exchanger

- 1 (M1) Supply air fan
- 2 (M2) Extract air fan
- 3 (F11) Supply air filter
- 4 (F12) Extract air filter
- 5 (HR-R) Rotary wheel-type heat exchanger
- 6 (EB1/WB1) Heating battery (electricity or water)
- 7 (F10-19) Overheating thermostat, manual reset\*
- 8 (P1) Supply air filter relay
- 9 (P2) Extract air filter relay
- 10 (P3) Supply air fan pressure relay\*
- 11 Connection box with automatic control
- 12 Overheating thermostat\*

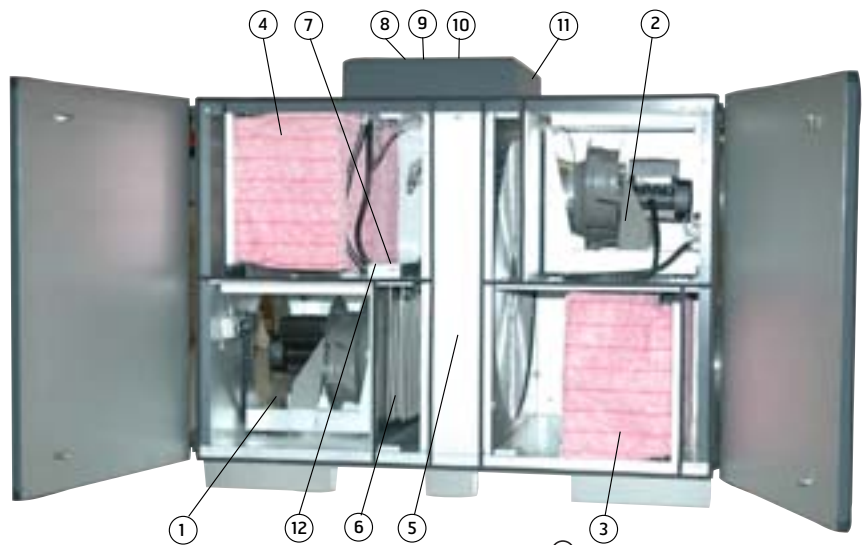

L60 R -  
with CS500  
control

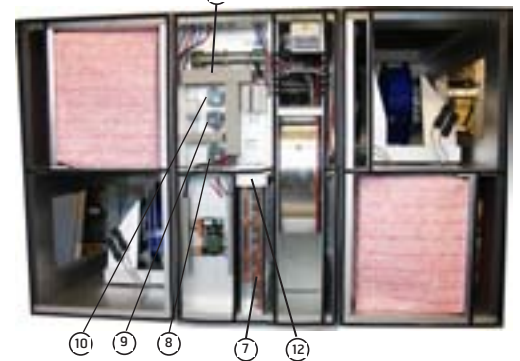

System Drawing - Rotary Wheel-type Heat Exchanger/  
Electric and Water Batteries

- M1 Supply air fan
- M2 Extract air fan
- M4 Rotor motor
- F11 Supply air filter
- F12 Extract air filter
- HR-R Rotary wheel-type heat exchanger
- P1 Supply air filter relay
- P2 Extract air filter relay
- P3 Supply air fan pressure relay\*
- B1 Supply air temperature sensor
- B3 Extract air temperature sensor\*\*
- B4 Outdoor air temperature sensor\*\*
- B5 Water battery temperature sensor (frost relay)
- F10 Overheating thermostat, manual reset\*
- F20 Overheating thermostat\*
- DA1 Air damper, exhaust air (not standard)
- DA2 Air damper, outdoor air (not standard)
- WB1 Heating battery, water
- EB1 Heating battery, electric
- P11 Trykksensor tilluftsvifte\*\*
- P12 Trykksensor avtrekksvifte\*\*

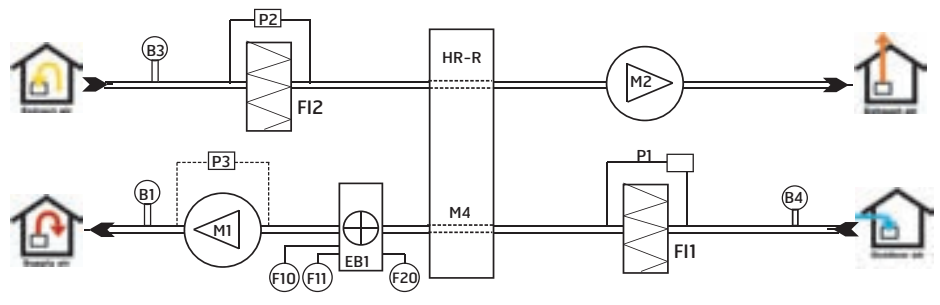

Fig. 9 Unit with electric heating battery

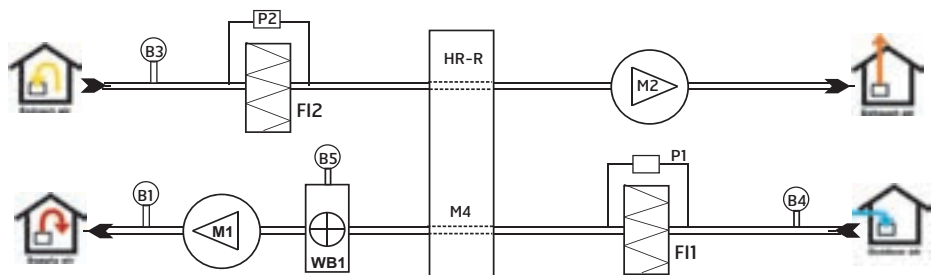

Fig. 10 Unit with water-based heating battery

\* Only with an electric battery

\*\* Only standard with CS1000 automatic control

## 7 Adjustment, Capacity and Sound Data

With the use of CS1000 automatic control, this is not necessary as it is integrated in the automatic control.

**△** The units have separate pressure measurement outlets. They are labelled on the unit.

The following formula is used:

$$Q = k \cdot \sqrt{\Delta P}$$

Q = Air flow rate (m<sup>3</sup>/h)

k = Factor

Δ P = Pressure read off (Pa)

**K-faktor**

L14 R	60
L20 R	87
L30 R	97
L40 R	122
L60 R	151

**Example:**

Unit L40 R Supply Air

Required: 2500 m<sup>3</sup>/h

L40 R has k factor= 124

Use formula:  $Q = k \cdot \sqrt{\Delta P}$

$$2500 = 122 \sqrt{\Delta P}$$

$$\frac{2500}{122} = \frac{122 \cdot \sqrt{\Delta P}}{122}$$

$$20.5 = \sqrt{\Delta P}$$

$$(20.5)^2 = \Delta P$$

$$\Delta P = 420$$

- Connect the pressure meter
- Adjust the fan until 420Pa is displayed on the instrument

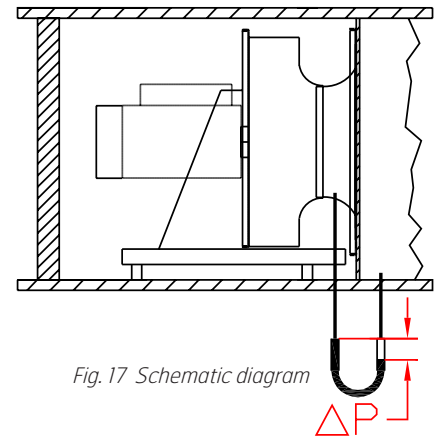

Fig. 17 Schematic diagram

You have now adjusted the supply air for the L40 rotor unit to a capacity of 2500 m<sup>3</sup>/h.

**Readout supply air level**

ΔP supply air fan is measured between PM1 and PR2.

**Readout extract air level**

ΔP extract air fan is measured between PM1 and PR2.

### Wiring diagram

**CS500**

L40RE  
L30RE  
L20RE  
L14RE

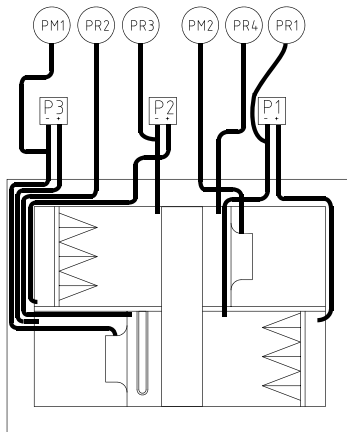

**CS500**

L40RW  
L30RW  
L20RW  
L14RW

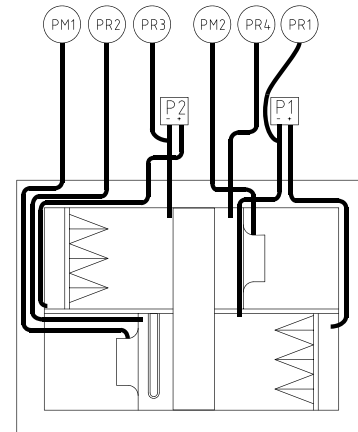

**CS1000**

L40RE  
L30RE  
L20RE  
L14RE

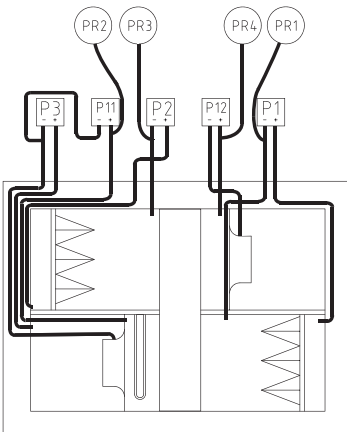

**CS1000**

L40RW  
L30RW  
L20RW  
L14RW

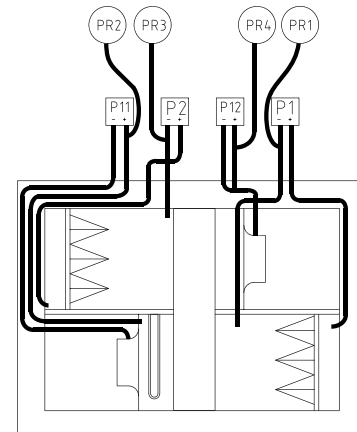

## 7.1 Cleaning

For cleaning over the rotor to work, the pressure difference between PR1 and PR3 (see Fig. 18) must be at least 100 Pa.

Use a pressure meter. Place the air hoses on PR1 and PR3.

If there is not a large enough pressure difference between PR1 and PR3, you can use throttle dampers to increase the negative pressure in the extract air side of the unit.

### When using units that do not have air flow rate or pressure regulation:

If throttle dampers are used to obtain the correct pressure ratio, the speed of the extract air fan must be increased manually.

## 7.2 Pressure Balance

It is important for there to be more negative pressure in the extract air chamber than in the supply air chamber for the leak direction to be correct so that the extract air does not enter the supply air.

This is measured after the unit has been adjusted (normal operation). The pressure ratio is adjusted by pulling the throttle plates gradually over the extract air inlet. The throttle plates are preinstalled in the unit. They are located between the extract air filter and the extract air inlet.

1. Connect the pressure sensor to the pressure outlets PR3 and PR2. Set plus on PR3 and minus on PR2. The instrument must display less than 0 Pa (for example -20). If the value is higher than 0 Pa, throttle dampers must be used.
2. Stop the unit and push the plates in a little so that they cover a little of the inlet.
3. Start the unit and measure again.
4. If the negative pressure in the extract air chamber is still less than in the supply air chamber, push the throttle plates a little further in.

### When using units that do not have air flow rate or pressure regulation:

If throttle dampers are used to obtain the correct pressure ratio, the speed of the extract air fan must be increased manually.

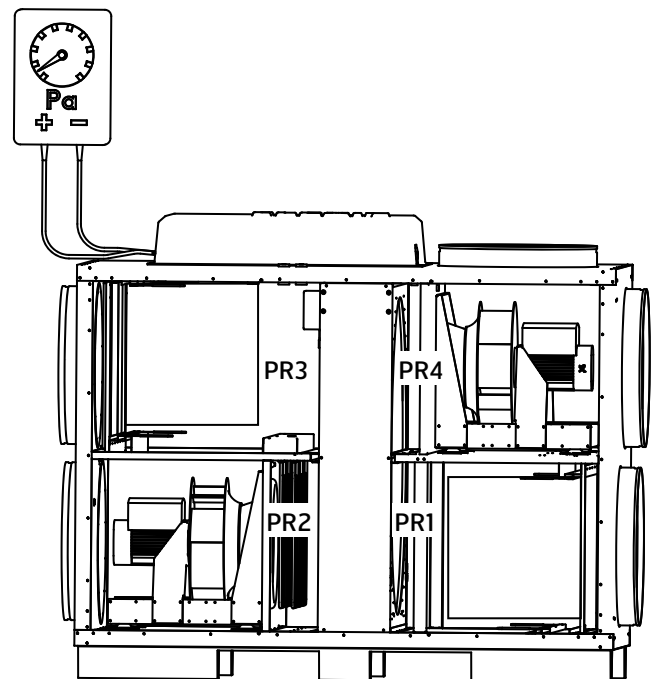

Fig. 18

- PR1:** Rotor pressure, intake side
- PR2:** Rotor pressure, supply air side
- PR3:** Rotor pressure, extract air side
- PR4:** Rotor pressure, exhaust air side



### 7.3 Capacity Diagram, Sound Data, Specifications - Flexit L14 R W/E

Supply air side (with F7 filter)

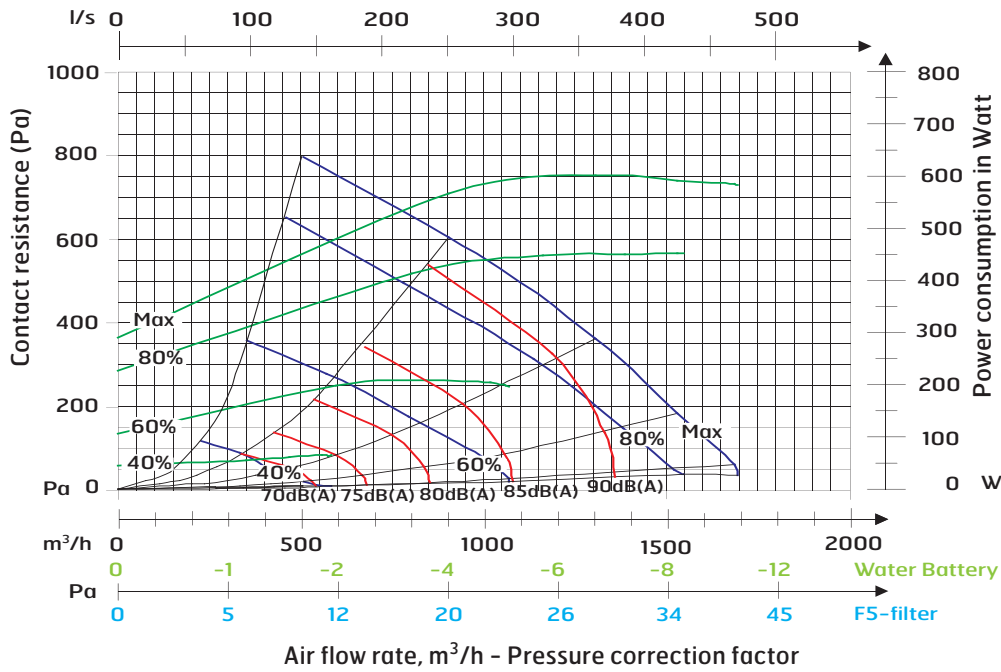

Extract air side (with F7 filter)

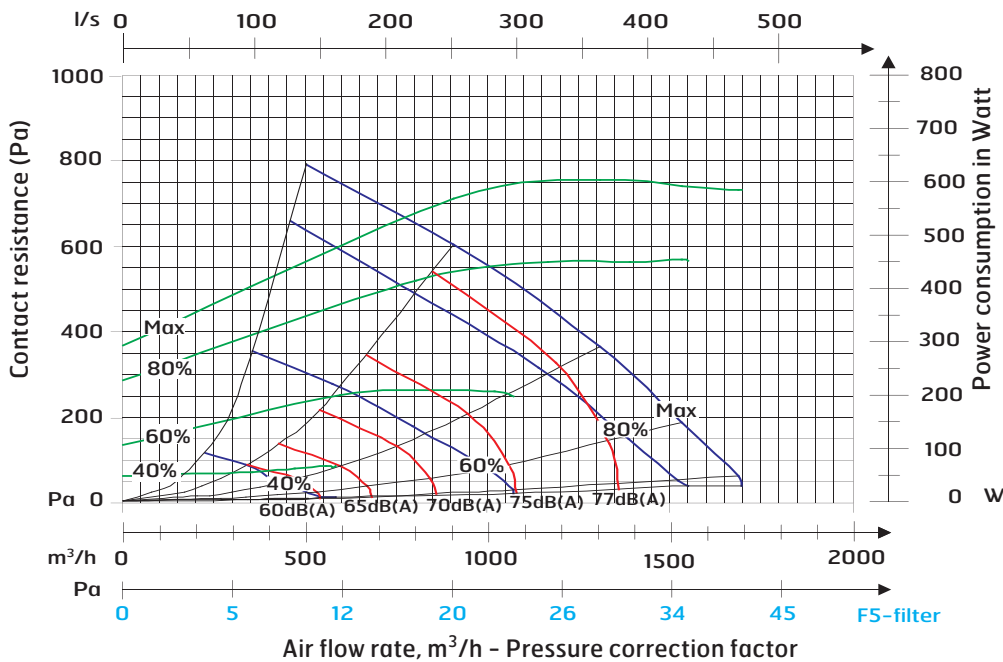

Sound data is given at sound power level  $L_wA$  in the capacity diagrams and is corrected with the table below for the various octave bands. Radiated noise produces  $L_w$  in the various octave bands and total  $L_wA$ . Radiated noise is estimated by finding the noise level from the supply air table and deduct the total value found in the correction factor table below.

**Correction factor for  $L_w$**

Hz	63	125	250	500	1000	2000	4000	8000	$L_wA$
Supply air	4	-1	-6	-2	-5	-8	-17	-27	
Extract air	6	1	-4	1	-8	-14	-21	-29	
Radiated	-58	-43	-43	-39	-45	-44	-45	-63	-37,1

Data for supply air is measured in accordance with ISO 5136, the "In duct method". Radiated noise is measured in accordance with ISO 9614-2. Bruel & Kjaer measuring equipment, type 2260.

- Blue curves: Air capacity at various capacity settings in Volt.
- Green curves: Supply air fan power consumption at various capacity settings.
- Red curves: Sound power level  $L_wA$ , cf. correction table.
- Light blue correction axis: Pressure increase using an EU-5 filter.
- Light green correction axis: Pressure reduction using a water battery.

### 7.4 Capacity Diagram, Sound Data, Specifications - Flexit L20 R W/E

Supply air side (with F7 filter)

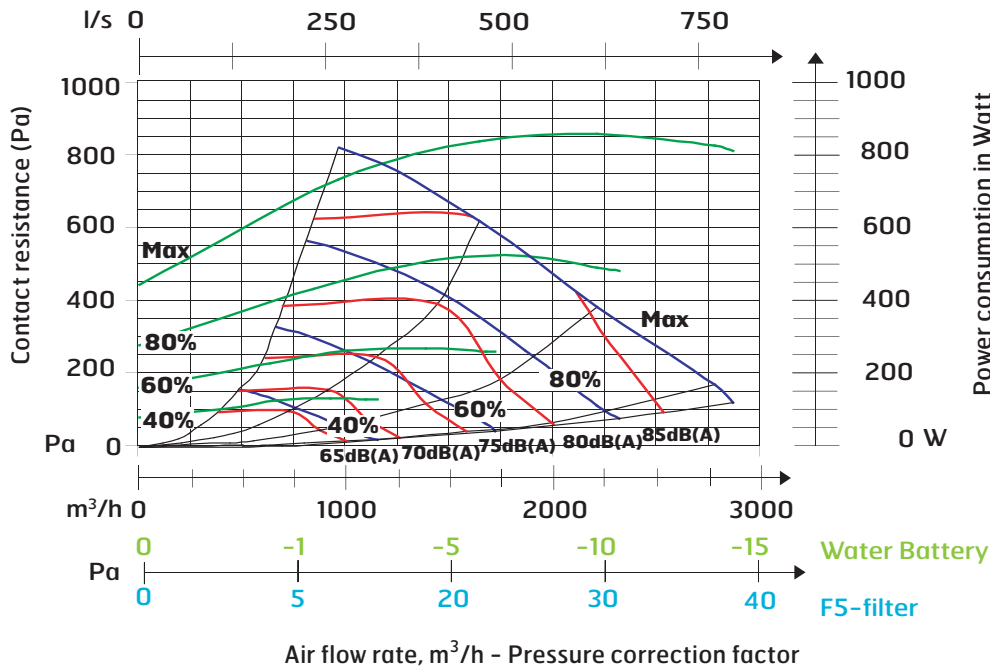

Extract air side (with F7 filter)

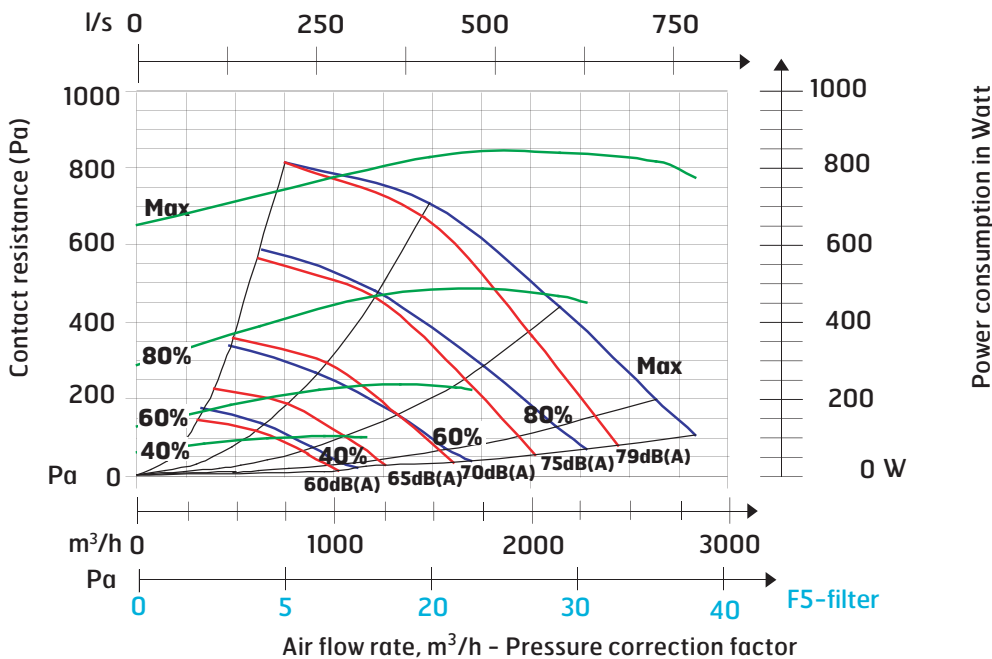

Sound data is given at sound power level LwA in the capacity diagrams and is corrected with the table below for the various octave bands. Radiated noise produces Lw in the various octave bands and total LwA. Radiated noise is estimated by finding the noise level from the supply air table and deduct the total value found in the correction factor table below.

**Correction factor for Lw**

Hz	63	125	250	500	1000	2000	4000	8000	LwA
Supply air	-5	-12	-4	-2	-4	-9	-18	-31	
Extract air	3	-3	5	-3	-16	-24	-37	-55	
Radiated	-45	-42	-44	-40	-44	-42	-47	-57	-37,1

Data for supply air is measured in accordance with ISO 5136, the "In duct method". Radiated noise is measured in accordance with ISO 9614-2. Bruel & Kjaer measuring equipment, type 2260.

- Blue curves: Air capacity at various capacity settings in Volt.
- Green curves: Supply air fan power consumption at various capacity settings.
- Red curves: Sound power level LwA, cf. correction table.
- Light blue correction axis: Pressure increase using an EU-5 filter.
- Light green correction axis: Pressure reduction using a water battery.

### 7.5 Capacity Diagram, Sound Data, Specifications - Flexit L30 R W/E

Supply air side (with F7 filter)

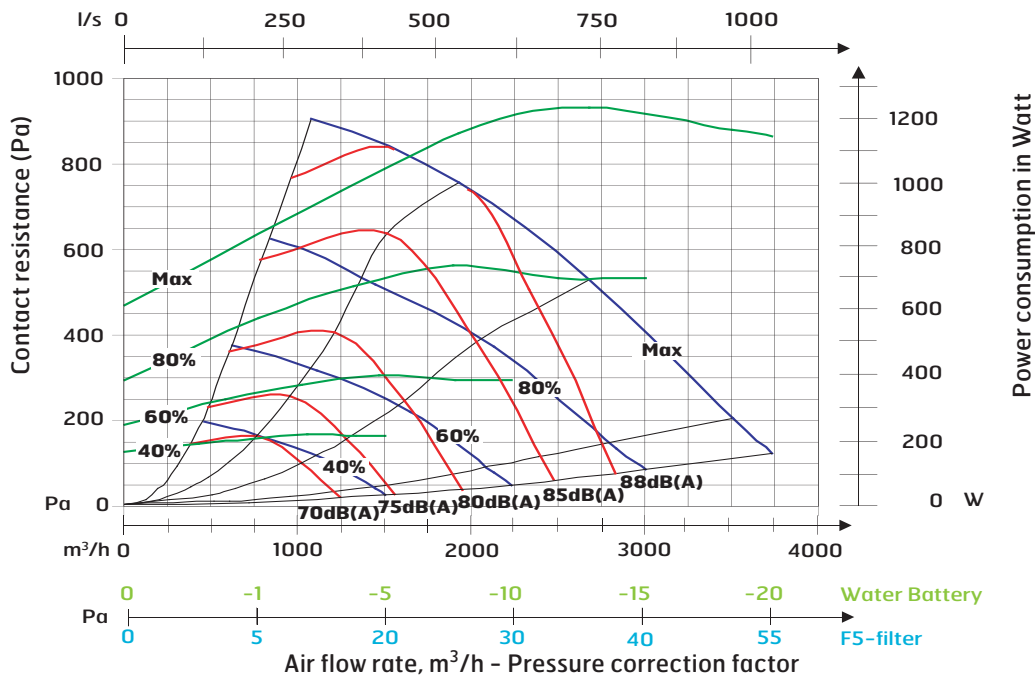

Extract air side (with F7 filter)

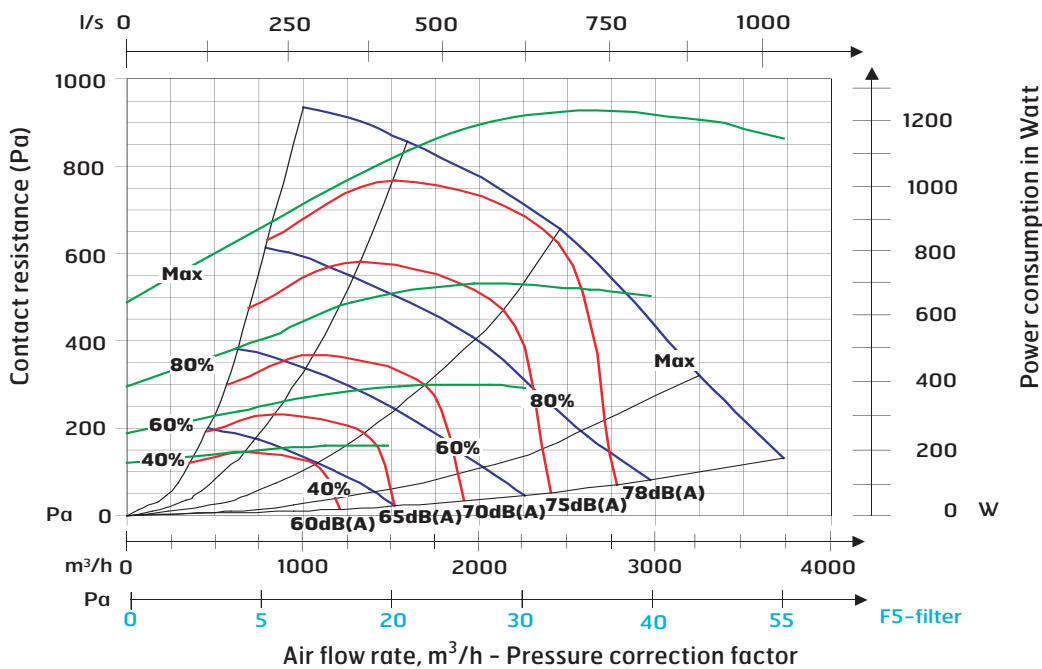

Sound data is given at sound power level LwA in the capacity diagrams and is corrected with the table below for the various octave bands. Radiated noise produces Lw in the various octave bands and total LwA. Radiated noise is estimated by finding the noise level from the supply air table and deduct the total value found in the correction factor table below.

**Correction factor for Lw**

Hz	63	125	250	500	1000	2000	4000	8000	LwA
Supply air	-2	-10	-2	-4	-3	-10	-18	-29	
Extract air	3	0	5	-1	-17	-24	-35	-50	
Radiated	-56	-43	-42	-39	-44	-44	-46	-64	-37,0

Data for supply air is measured in accordance with ISO 5136, the "In duct method". Radiated noise is measured in accordance with ISO 9614-2. Bruel & Kjaer measuring equipment, type 2260.

- Blue curves: Air capacity at various capacity settings in Volt.
- Green curves: Supply air fan power consumption at various capacity settings.
- Red curves: Sound power level LwA, cf. correction table.
- Light blue correction axis: Pressure increase using an EU-5 filter.
- Light green correction axis: Pressure reduction using a water battery.

### 7.6 Capacity Diagram, Sound Data, Specifications - Flexit L40 R W/E

Supply air side (with F7 filter)

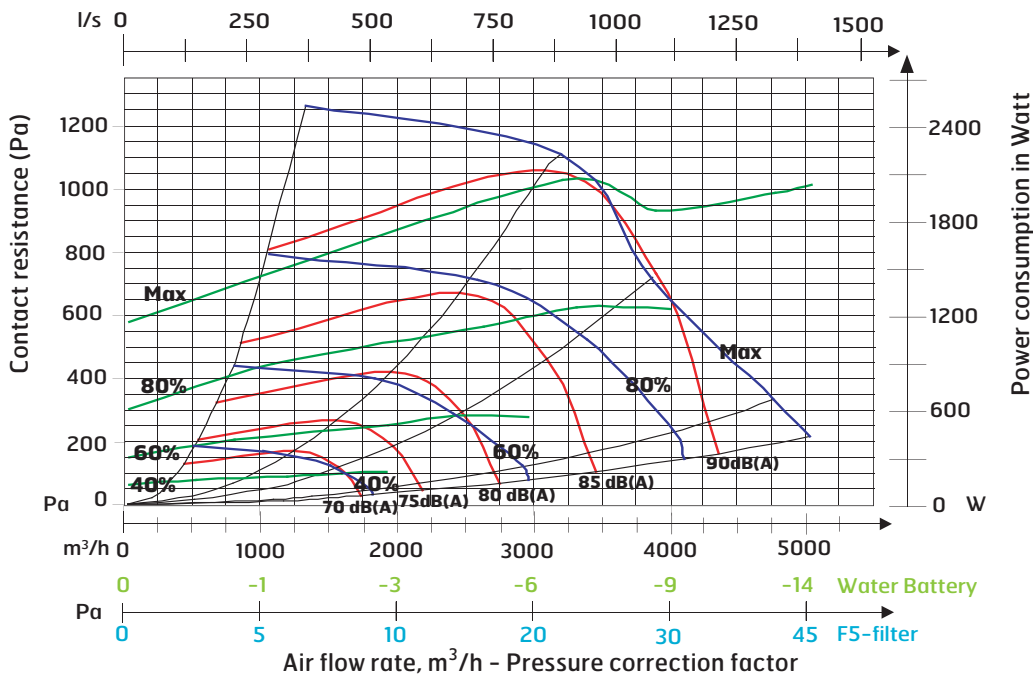

Extract air side (with F7 filter)

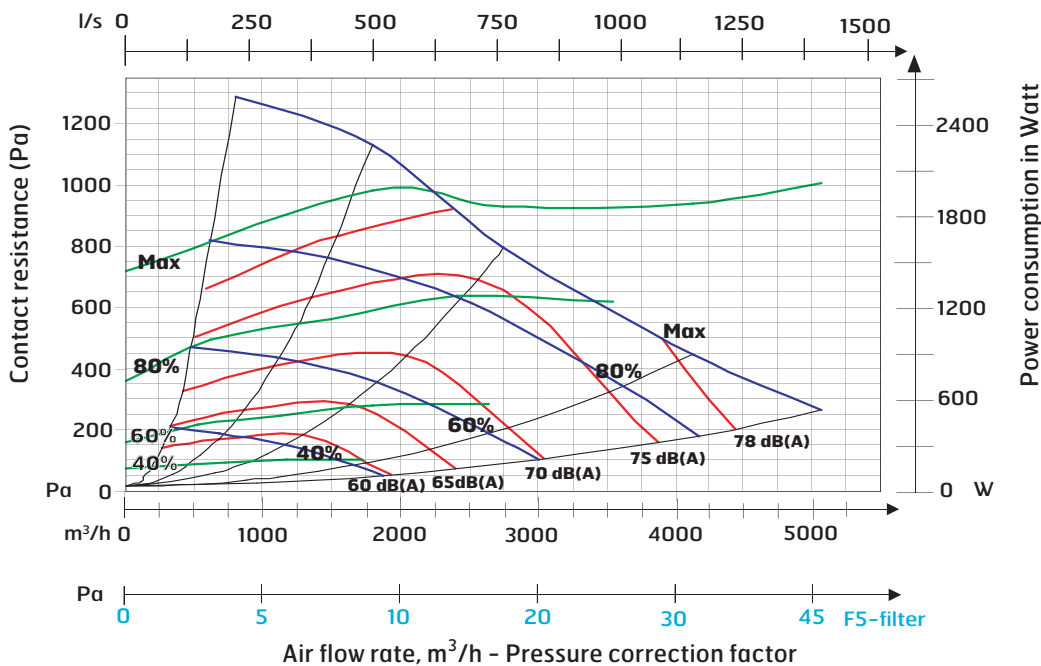

Sound data is given at sound power level  $L_{wA}$  in the capacity diagrams and is corrected with the table below for the various octave bands. Radiated noise produces  $L_w$  in the various octave bands and total  $L_{wA}$ . Radiated noise is estimated by finding the noise level from the supply air table and deduct the total value found in the correction factor table below.

**Correction factor for  $L_w$**

Hz	63	125	250	500	1000	2000	4000	8000	$L_{wA}$
Supply air	-3	-4	-3	-3	-3	-11	-20	-31	
Extract air	6	3	3	0	-13	-22	-37	-49	
Radiated	-47	-43	-41	-38	-40	-40	-46	-58	-34.3

Data for supply air is measured in accordance with ISO 5136, the "In duct method". Radiated noise is measured in accordance with ISO 9614-2. Bruel & Kjaer measuring equipment, type 2260.

- Blue curves: Air capacity at various capacity settings in Volt.
- Green curves: Supply air fan power consumption at various capacity settings.
- Red curves: Sound power level  $L_{wA}$ , cf. correction table.
- Light blue correction axis: Pressure increase using an EU-5 filter.
- Light green correction axis: Pressure reduction using a water battery.

### 7.7 Capacity Diagram, Sound Data, Specifications - Flexit L60 R W/E

Supply air side (with F7 filter)

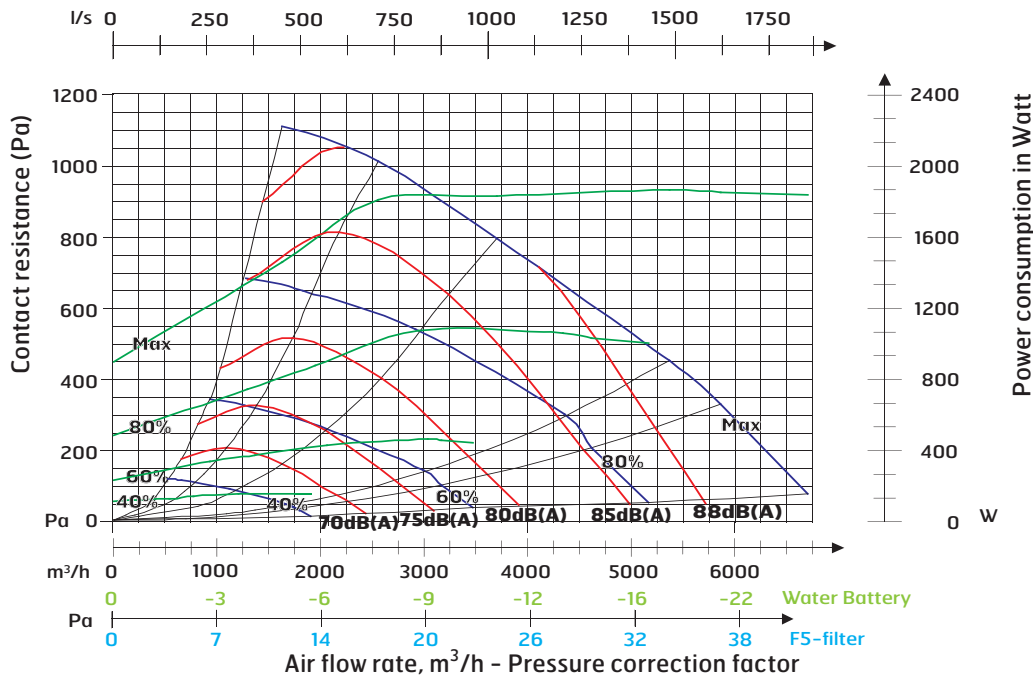

Extract air side (with F7 filter)

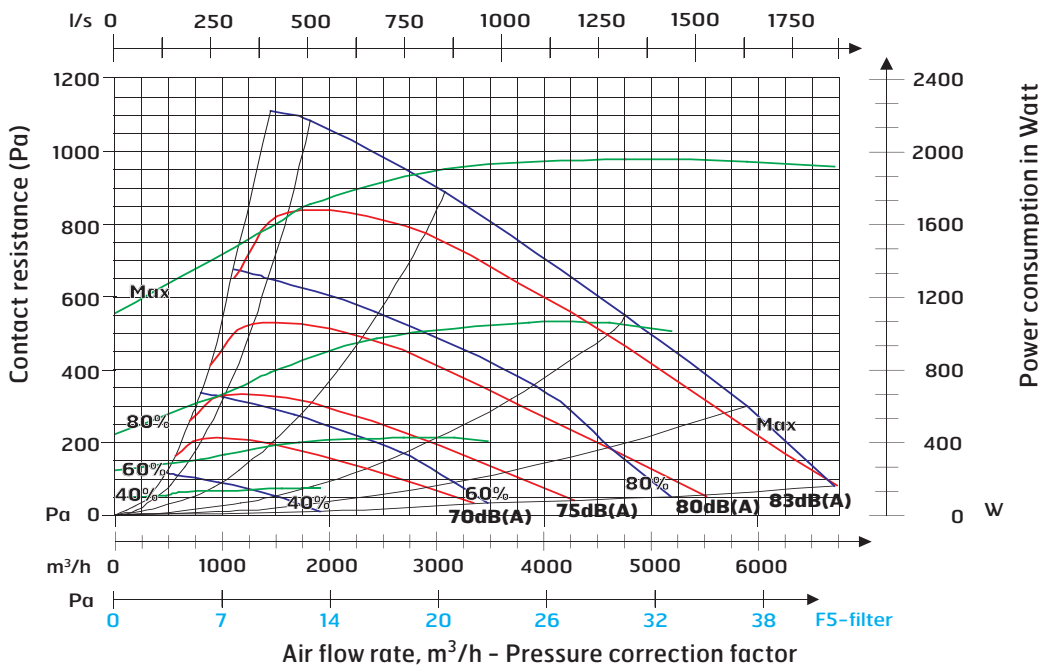

Sound data is given at sound power level LwA in the capacity diagrams and is corrected with the table below for the various octave bands. Radiated noise produces Lw in the various octave bands and total LwA. Radiated noise is estimated by finding the noise level from the supply air table and deduct the total value found in the correction factor table below.

**Correction factor for Lw**

Hz	63	125	250	500	1000	2000	4000	8000	LwA
Supply air	-2	-4	-5	-3	-3	-10	-18	-33	
Extract air	9	9	3	-3	-12	-23	-36	-49	
Radiated	-47	-36	-33	-35	-35	-37	-42	-53	-30,7

Data for supply air is measured in accordance with ISO 5136, the "In duct method". Radiated noise is measured in accordance with ISO 9614-2. Bruel & Kjaer measuring equipment, type 2260.

- Blue curves: Air capacity at various capacity settings in Volt.
- Green curves: Supply air fan power consumption at various capacity settings.
- Red curves: Sound power level LwA, cf. correction table.
- Light blue correction axis: Pressure increase using an EU-5 filter.
- Light green correction axis: Pressure reduction using a water battery.

## 8 Maintenance

The system should be inspected regularly. This must be performed by qualified operating personnel. The inspection should be performed twice a year, preferably in the spring and autumn. If a water battery is used to heat the air, check the system for water leaks. Listen for strange sounds and check for abnormal vibrations. Check at regular intervals that the air intake is free of snow and leaves. The inspection and maintenance of fans, recovery systems, air dampers, filters and heating batteries are essential to achieve optimal performance.

**Rotor:** As the system has filters installed with a high tightness class, it is not normally necessary to clean the rotor. If it should still be necessary, dust can be removed with a soft brush. Further cleaning is possible if you remove the rotor, spray it with fat-soluble detergent and then blow it clean from the opposite side. Distance approximately 60 mm and max. pressure 8,0 bar. Check the drive belt and tighten it if necessary. Check that all seals around the rotor are intact and tight.



**Do not use detergent that is harmful to aluminium or the environment.**

**Air dampers:** The air damper plates are suspended in plastic bearings and do not need lubrication. The individual air damper plates are connected via an arm system that does not need lubrication either. Check every year that the air damper is tight. If the air damper is not properly tight, it can be corrected by adjusting the air damper motor or possibly adjusting the arm tension.

**Filters:** How frequently filters need replacing depends on the dust concentration in the air that passes through the filters. It is very important to replace filters to ensure that the system works properly. Filters must be replaced when the filter replacement lamp on the control panel lights up. They must be replaced at least once a year.

**Heating battery:** The heating battery, electric or water-based, will be exposed to dirt very rarely, as the system has filters fitted with a high tightness class. If cleaning should still be necessary, you can use compressed air, which is blown in the opposite direction to the air flow, or a vacuum cleaner with a soft nozzle. Cleaning must be done carefully to ensure that the battery's fins are not damaged.

Inspect the cables to the electric battery at least twice a year. Check for damaged cables and components. Tighten all terminal blocks for power supply to the electric battery (elements, contactors, SSR) and other terminal blocks.

**Corrosion damage:** If there is corrosion damage to fins or pipes, this may indicate moisture or corrosive air. The cause must be found and remedied.

### 8.1 Troubleshooting

<b>Fault</b>	<b>Remedial action</b>	<b>Component</b>
The unit does not start	<ol style="list-style-type: none"> <li>1. Check the fuses and that there is power to the unit</li> <li>2. Check the control panels in case the unit has stopped on account of an alarm or the service switch is off</li> <li>3. Check that the unit is not in STOP mode</li> </ol>	Fuses, overheating protection, motor protection or frost sensor with a water battery
The heating does not come on	<ol style="list-style-type: none"> <li>1. Check that the pressure relay is OK (only with an electric battery)</li> <li>2. Check that the valve has control current (over 2 V) and supply voltage (with a water battery)</li> <li>3. Check the temperature sensors</li> </ol>	Pressure relay Sensors Valve
The fans do not start	<ol style="list-style-type: none"> <li>1. Check the operating setting</li> <li>2. Check that the fans have operating voltage and control current (over 2 V)</li> <li>3. Check that the motor protection is not active</li> </ol>	Motor protection
A red lamp lights up for motor protection	<ol style="list-style-type: none"> <li>1. Check the rotor control box</li> <li>2. Check that the rotor rotates easily</li> <li>3. Ensure that the space between the rotor guard and sensor magnet is 5-7 mm</li> <li>4. Switch off the fuses and the service switch. Remove the electrical cover on the motors. Switch on the power to the units and check the operation indication on the motor (LED on the electrical box on the motor. Green flash OK. Red light, contact service).</li> </ol>	Rotormotor

## 9 Technical Specifications

### 9.1 Technical Specifications - L14 R

	<b>L14 RW</b>	<b>L14 RE 3.6kW</b>
Rated voltage	230V	400V
Fuse	1 x 10 A	3 x 13 A
Rated current, total	9 A	13 A
Rated power, total	1300 W	4900 W
Rated power, electric battery		3600 W
Rated power, fans	2 x 485 W	2 x 485 W
Fan type	B-wheel	B-wheel
Fan motor control	EC-stepless	EC-stepless
Max. fan speed	3700 rpm	3700 rpm
Filter type (SUP/EXTR)	F 7	F 7
Filter dimensions (WxHxD, mm)	795x380x85	795x380x85
Number of bags	-	-
Weight	175 kg	175 kg
Duct connection	Ø 315 mm	Ø 315 mm
Height	1144 mm	1144 mm
Width	1127 mm	1127 mm
Depth	905 mm	905 mm

### 9.2 Technical Specifications - L20 R

	<b>L20 RW</b>	<b>L20 RE 6kW</b>
Rated voltage	400V	400V
Fuse	3 x 10 A	3 x 16 A
Rated current, total	5.5 A	14 A
Rated power, total	1810 W	7810 W
Rated power, electric battery		6000 W
Rated power, fans	2 x 750 W	2 x 750 W
Fan type	B-wheel	B-wheel
Fan motor control	Frequency converter	Frequency converter
Max. fan speed	3200 rpm	3200 rpm
Filter type (SUP/EXTR)	F7	F7
Filter dimensions (WxHxD, mm)	895x400x300	895x400x300
Number of bags	18	18
Weight	252.5 kg	252.5 kg
Duct connection	Ø400	Ø400
Height	1244 mm	1244 mm
Width	1627 mm	1627 mm
Depth	1006 mm	1006 mm

## 9.2 Technical Specifications - L30 R

	<b>L30 RW</b>	<b>L30 RE 12kW</b>
Rated voltage	400 V	400 V
Fuse	3 x 10 A	3 x 32 A
Rated current, total	7.9 A	25 A
Rated power, total	2600 W	14600 W
Rated power, electric battery		12000 W
Rated power, fans	2 x 1100 W	2 x 1100 W
Fan type	B-wheel	B-wheel
Fan motor control	Frequency converter	Frequency converter
Max. fan speed	3000 rpm	3000 rpm
Filter type (SUP/EXTR)	F 7	F 7
Filter dimensions (WxHxD, mm)	995x450x350	995x450x350
Number of bags	20	20
Weight	330 kg	330 kg
Duct connection	Ø400 mm	Ø400 mm
Height	1350 mm	1350 mm
Width	1727 mm	1727 mm
Depth	1108 mm	1108 mm

## 9.3 Technical Specifications - L40 R

	<b>L40 RW</b>	<b>L40 RE 12kW</b>
Rated voltage	400 V	400 V
Fuse	3 x 13 A	3 x 32 A
Rated current, total	8.8 A	26 A
Rated power, total	4100 W	16100 W
Rated power, electric battery		12000 W
Rated power, fans	2 x 1400 W	2 x 1400 W
Fan type	B-wheel	B-wheel
Fan motor control	Frequency converter	Frequency converter
Max. fan speed	3000 rpm	3000 rpm
Filter type (SUP/EXTR)	F 7	F 7
Filter dimensions (WxHxD, mm)	2 x (550x500x400)	2 x (550x500x400)
Number of bags	10	10
Weight	363.5 kg	363.5 kg
Duct connection	Ø500 mm	Ø500 mm
Height	1455 mm	1455 mm
Width	1777 mm	1777 mm
Depth	1215 mm	1215 mm



**9.4 Technical Specifications - L60 R**

	<b>L60 RW</b>	<b>L60 RE 15kW</b>
Rated voltage	400 V	400 V
Fuse	3 x 13 A	3 x 40 A
Rated current, total	11 A	33 A
Rated power, total	4000 W	19000 W
Rated power, electric battery	-	15000 W
Rated power, fans	2 x 3000 W	2 x 3000 W
Fan type	B-wheel	B-wheel
Fan motor control	EC-stepless	EC-stepless
Max. fan speed	3000 rpm	3000 rpm
Filter type (SUP/EXTR)	F 7	F 7
Filter dimensions (WxHxD, mm)	4 x (625x600x500)	4 x (625x600x500)
Number of bags	12	12
Weight	540 kg	540 kg
Duct connection	400x900 mm	400x900 mm
Height	1478 mm	1478 mm
Width	2157 mm	2157 mm
Depth	1367 mm	1367 mm

**10 Commissioning**



**The unit must not be started until all documentation has been studied and all electrical and plumbing work has been performed.**

- 1 Familiarise yourself well with the documentation for the automatic control system
- 2 Programme the various operating times and speeds (possibly including stop)
- 3 Check that the correct temperature regulation and temperature settings have been selected. Are the sensors located correctly?
- 4 Check that the fans rotate freely
- 5 Check that all air dampers work. The unit must not be operated with closed air dampers.
- 6 Check that all doors are properly closed
- 7 Start the unit as described in the documentation for the automatic control
- 8 Check that the heat recovery system works correctly
- 9 Check that the heat control works correctly
- 10 If the unit has a water battery, you must test the frost function. Cool the frost sensor to below 5 °C. The unit should stop and the air dampers close.
- 11 See Chap. 8.1 Troubleshooting and follow the instructions
- 12 Tighten all terminal blocks after commissioning

## 11 EU Declaration of Conformity

This declaration confirms that the products meet the requirements of the following Council Directives:

**89/336/EEC**    **Electromagnetic Compatibility**

**73/23/EEC**    **Low Voltage Directive**

**98/37/EEC**    **Machinery Directive**

**Manufacturer:**                      FLEXIT AS, Televeien 15, N-1870 Ørje  
Tel: +47 69 81 00 00    Fax +47 69 81 00 80

**Type of equipment:**                86 42 000            **Ventilation equipment for mounting in ducts**

**Model:**                                **L14 RE**  
**L14 RW**  
**L20 RE**  
**L20 RW**  
**L30 RE**  
**L30 RW**  
**L40 RE**  
**L40 RW**  
**L60 RE**  
**L60 RW**

**Serial no.:**                            .....

**The following harmonized European standards or technical specifications have been applied:**

Safety standard:	EN 60335-2-80:2003 EN 60335-1:2002; A11
EMF standard:	EN 50366:2003
EMC standard:	EN 55014-1:2000; A1; A2 EN 61000-3-2:2000 EN 61000-3-3:1995; A1 EN 55014-2:2:1997; A1

**FLEXIT AS** Ørje 01/09/2006



**Pål J. Martinsen**  
General Manager

*The right to give notice of lack of conformity applies to this product in accordance with the existing terms of sale, provided that the product is used correctly and maintained. Filters are consumables.*



*The symbol on the product shows that this product must not be treated as household waste. It must be taken to a reception station for recirculation of electric and electronic equipment. By ensuring the correct disposal of the equipment, you will contribute to preventing the negative consequences for the environment and health that incorrect handling may entail. For further information on recirculation of this product, please contact your local authority, your refuse collection company or the company from which you purchased it.*

*Notice of lack of conformity as a result of incorrect or defective installation must be submitted to the installation company responsible. The right to give notice of lack of conformity may lapse if the system is used incorrectly or maintenance is grossly neglected.*

## 12 Product/Environmental Declaration

**The declaration applies to ventilation units Flexit S9, S12, S20, S30, L12, L14, L18, L20, L30, L40, L50 and L60**

### Materials:

#### Materials with which the user or treated air come into contact:

- The unit's outer walls are made of galvanised steel DX51D+Z275 (NS-EN 10142)
- The rotor exchanger made of aluminium
- Miscellaneous electric cables with PVC insulation
- Electric motors consisting of galvanised steel, aluminium and copper
- Heating elements made of steel
- Air filters of glass fibre and sheet steel
- EVA melting glue

#### Materials in the unit with which service personnel may come into contact:

- Plastic-insulated electric cables
- Miscellaneous other electrical components
- Insulation of type Rockwool mat

#### Other materials that may occur in small quantities:

- Silicone sealant
- Polyethylene foamed plastic
- EPDM rubber gaskets
- Miscellaneous steel screws, nuts and pop rivets, plus small quantities of copper and brass.

### Safety:

#### Materials:

The materials are considered to be completely harmless to users.

#### Use:

The unit is an electrical appliance which must be made dead for service and inspection.

The unit also contains rotating motors that must have time to stop before the inspection door is opened, plus a heating element with a high operating temperature.

